

2024 PAS Patterns

Legend for Patterns

READ instructions carefully, diagrams may be abbreviated

Walk or Hand Gallop or -----

Trot, Jog or Show Gait - - - - -

Sitting Trot - . - . - . - . - . -

Extended Trot or Jog — . . — . . — . . -

Canter or Lope or Hand Gallop _____

Back  or ||||

Markers ▲ or (A)

Sidepass // // // //

Judge (J)

When a pattern is finished, either line up or exit the arena as directed by the ring steward.

Draft Showmanship

Enter arena at trot and line horse up on a $\frac{3}{4}$ view facing the arena fence.

When judge signals, back horse 5 steps off rail, turn and go to judge. (As horse leaves line up other exhibitors will move their horses down the wall and wait for judge's signal)

1. Walk horse away from judge $\frac{1}{2}$ way down ring, trot 2nd half.
2. Make a golf club turn and continue walk $\frac{1}{2}$ way back to judge, trot 2nd half.
3. Stop and pose horse for inspection. (May turn horse 45° angle either direction.)
4. When excused, go to the end of the line and move up until returned to the original position.

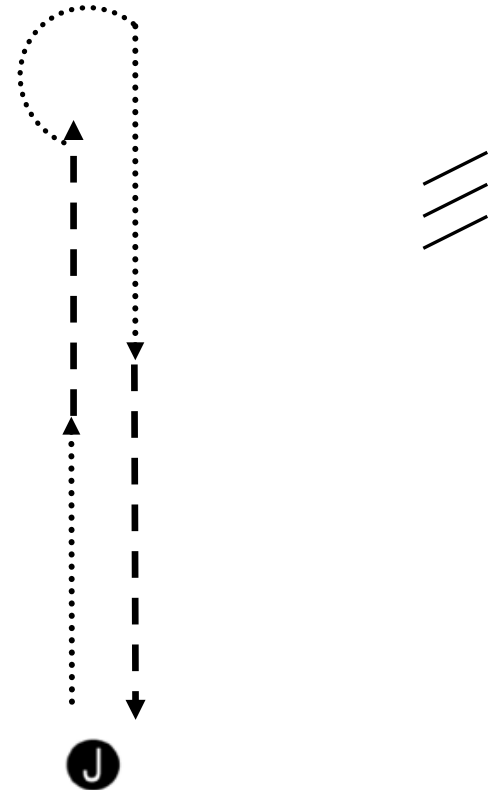

Driving Reinsmanship

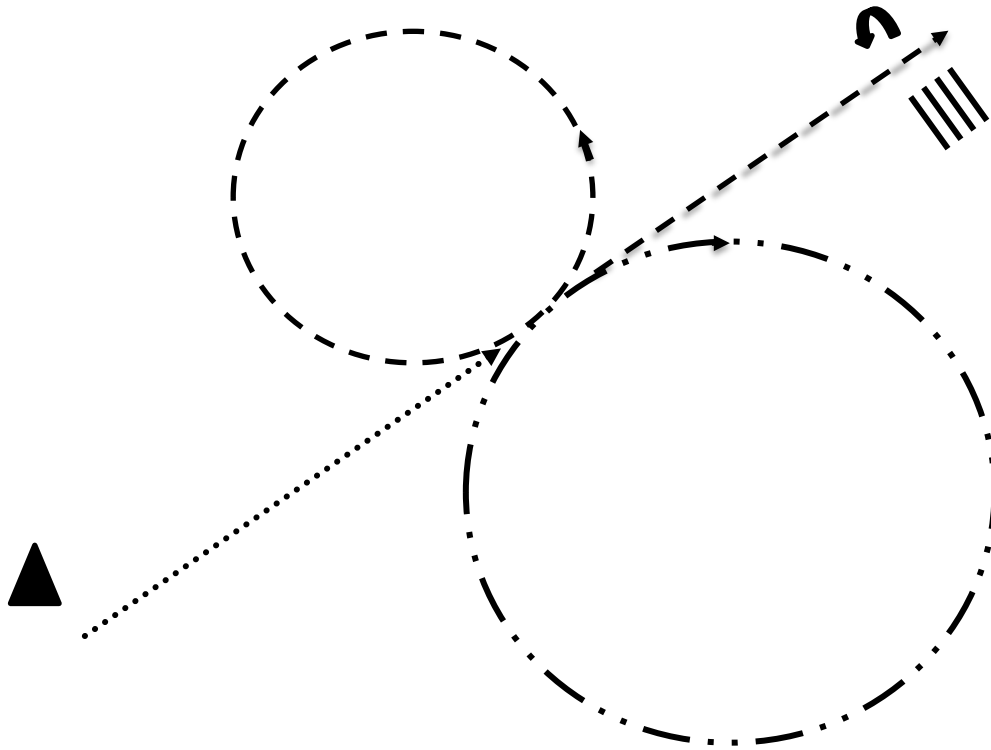

Be ready at cone.

1. Walk across diagonal to center.
2. Working Trot or Park Gait medium circle to left.
3. Strong Trot or Road Gait large circle to right.
4. Continue across diagonal at the Working Trot or Park Gait.
5. Stop & back four steps.
6. Fan turn 90° left.

Exit at the walk.

Cones-10ft apart

Bridge-4'x8'

Box- Sm Eq:12 ft long x 7ft wide, box opening 6ft wide. Horses: 20ft long x 12ft wide, box opening 7 ft wide.

Poles for drive through 6 inches apart

Rope/lime circle-4ft diameter for horse,
2 ft for small equine

Driven Trail

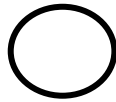
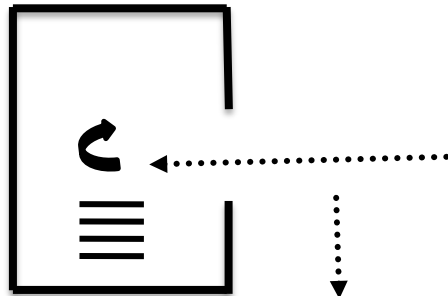

EXIT

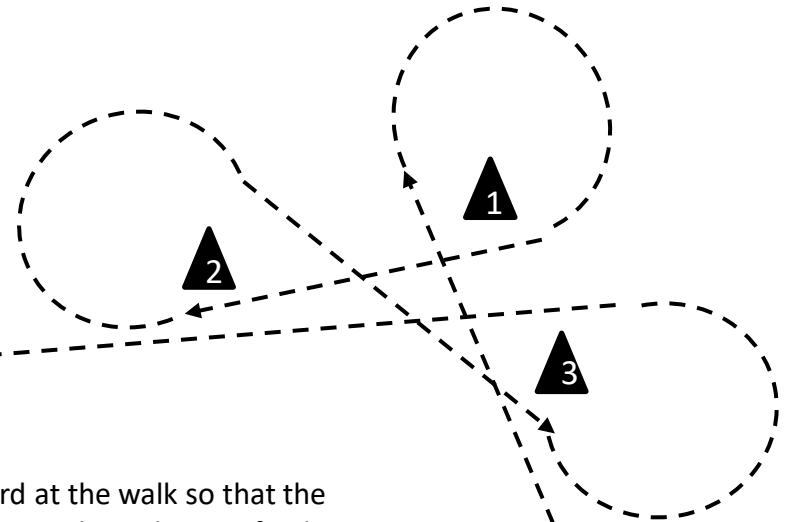

1. Drive forward at the walk so that the right wheel runs through pair of poles as shown.
2. Trot pattern around cones and to chute.
3. Walk into chute & turn right until completely inside box.
4. Back to edge of box and then walk out of box and to bridge.
5. Walk to and over bridge. When horse has stepped off bridge, halt vehicle on top of bridge for 5 seconds and continue walking to circle.
6. Place left wheel in circle and turn 360° left. Walk to exit.



ENTER



Small Equine Showmanship

**** Be ready at A****

1. Trot to and around B.
2. Walk from B until past judge.
3. Back until horse's hip is even with Judge.
4. Perform a 90° turn.
5. Trot to Judge.
6. Stop and set up for inspection.
7. When dismissed, perform a 270° turn.
8. Walk straight away from Judge.

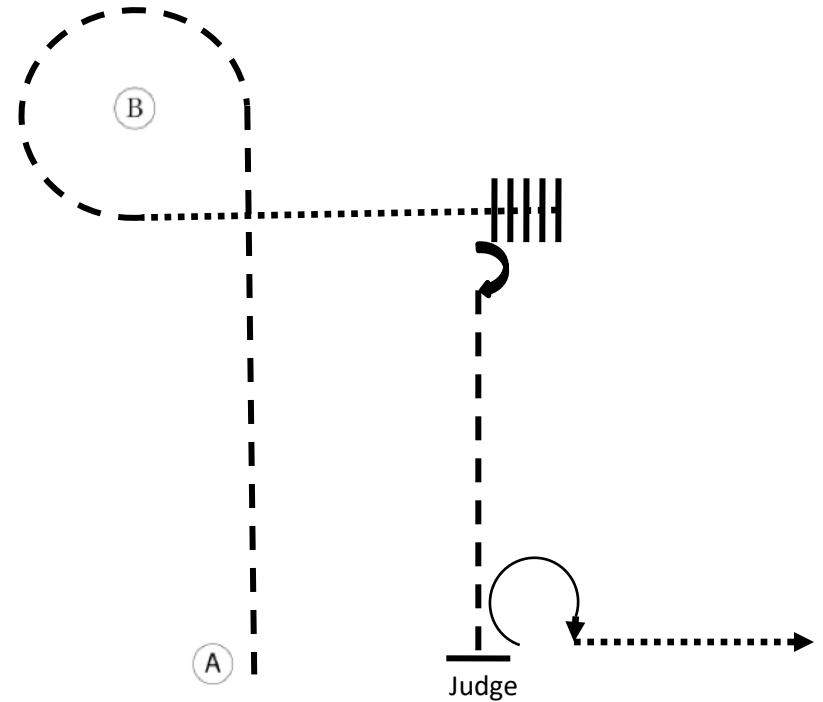

Small Equine Hunter in-Hand

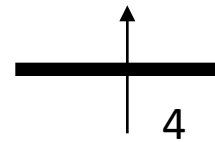
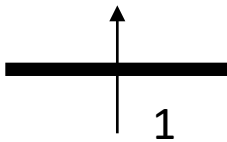
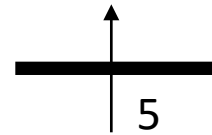
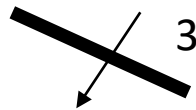
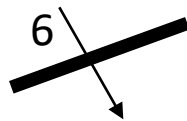
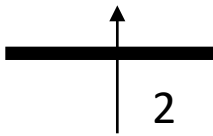

Fence Heights: 12"

Small Equine Jumpers

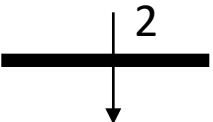
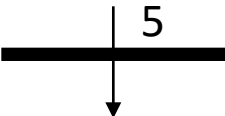
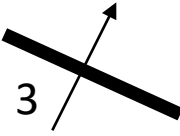
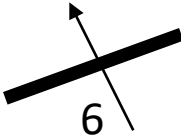
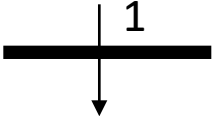
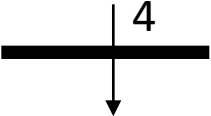

Fence Heights: 12"

Easy Gaited & Saddle Type Showmanship

** Be ready at A**

1. When acknowledged, walk halfway to Judge.
2. Stop and perform a 90° turn.
3. Back approximately one-horse length.
4. Trot/Show Gait a half circle to Judge.
5. Stop and set up for inspection.
6. When dismissed, perform a 180° turn and walk straight away from Judge.

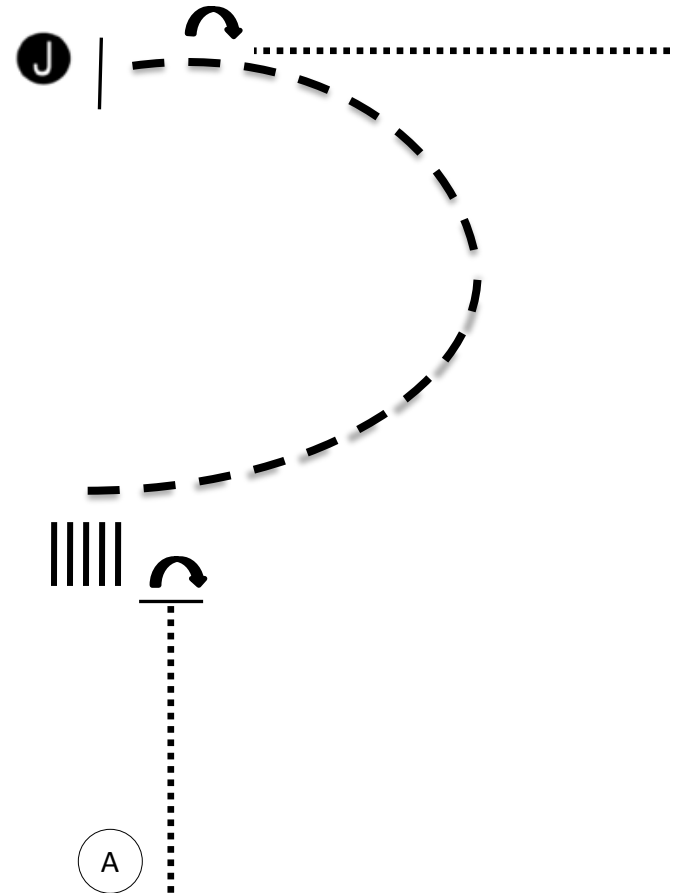

Saddle Seat Equitation

**** Be ready at A****

1. Walk from A to B. Stop and perform a 90° turn on the forehand to the left.
2. Posting trot through serpentine to D, demonstrating the correct diagonals.
3. At D, stop and perform a 180° turn on the haunches to the left.
4. Canter on the right lead a half circle to the right from D to C.
5. At C, perform a simple change and canter on the left lead a half circle to the left from C to B.
6. At the B, stop and back four steps.

****Exit at the Trot.****

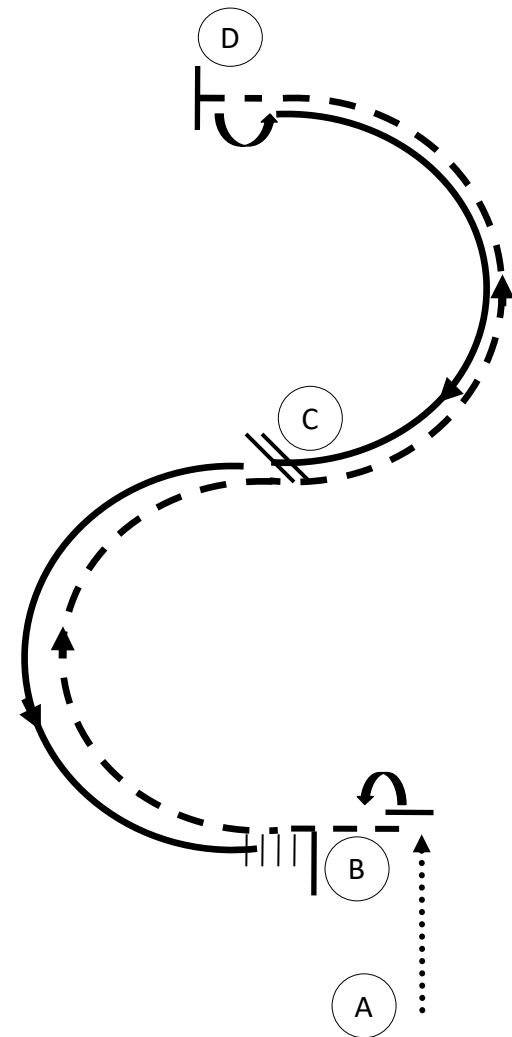

Easy Gaited Equitation

**** Be ready at A****

1. Show Gait to and around B.
2. Halfway between B and C, break to a Show Walk and Show Walk until even with C.
3. Pick up the Show Gait and Show Gait around C and D back to B.
4. Stop at B and back at least 5 steps.
5. Exit at a show walk.

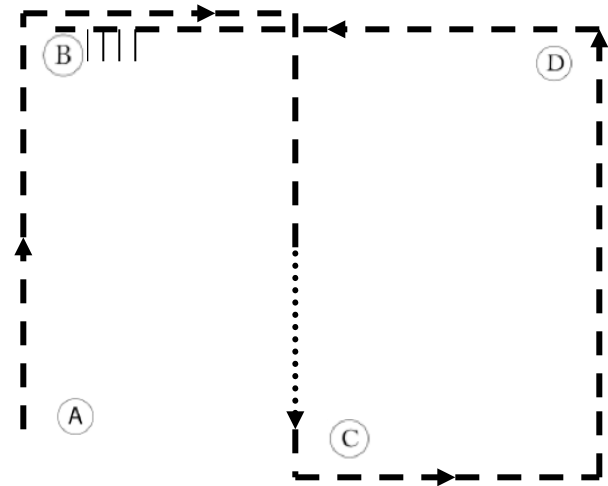

Easy Gaited Horsemanship

**** Be ready at A****

1. Show Walk from A to B.
2. At B, Show Gait a circle to the right.
3. Show Gait a circle to the left.
Continue to Show Gait to C.
4. At C, stop and back at least 5 steps.
5. Turn 180° to the left and exit at a Show Walk.

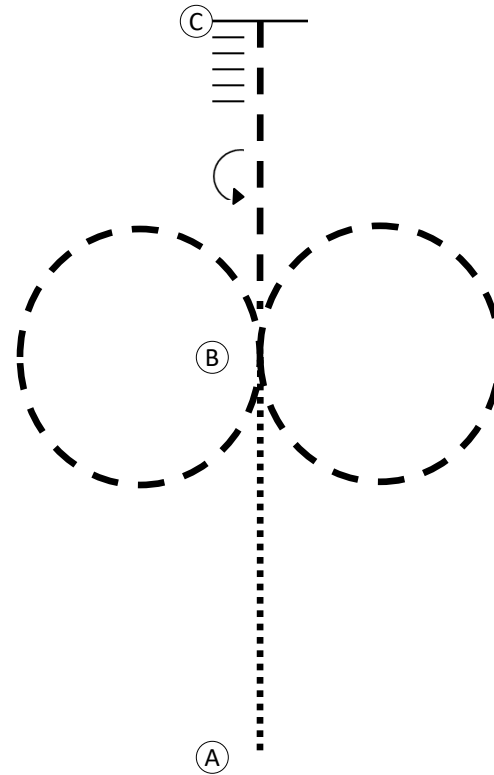

Ranch Showmanship

**** Be ready at A****

1. Walk from A to B.
2. Stop and perform a 270° turn.
3. Trot around C to the Judge. Set up for inspection.
4. When dismissed, back 4 steps and perform a 90° turn.
5. Trot to the exit.

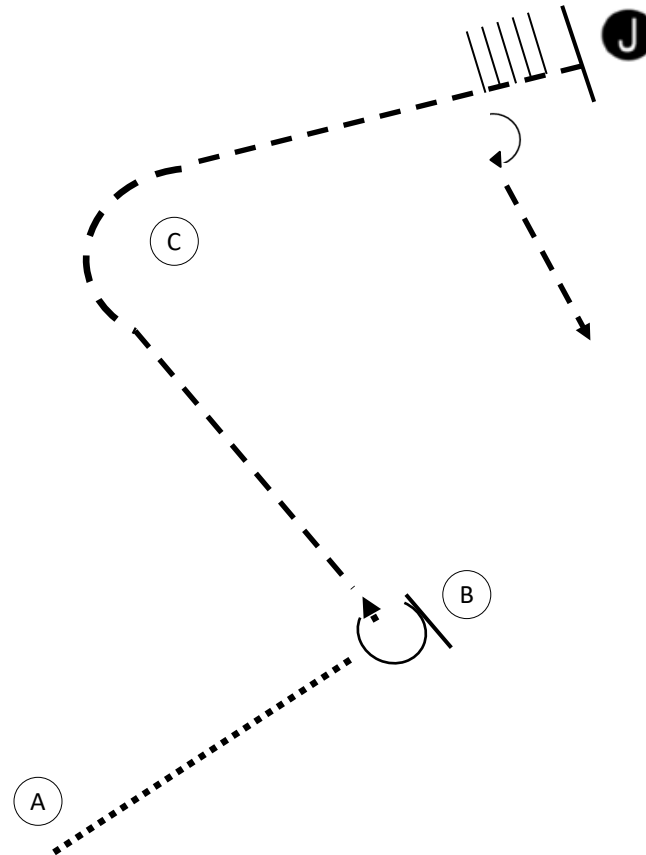

Ranch Horsemanship

****Be ready before A.****

1. Walk to A.
2. From A, Trot to B.
3. Stop at B and perform a 360° turn to the left.
4. Lope a loop to the left as shown.
5. At B, Extended Trot and continue to C.
6. At C stop and back 5 steps.

****Exit at the Trot.****

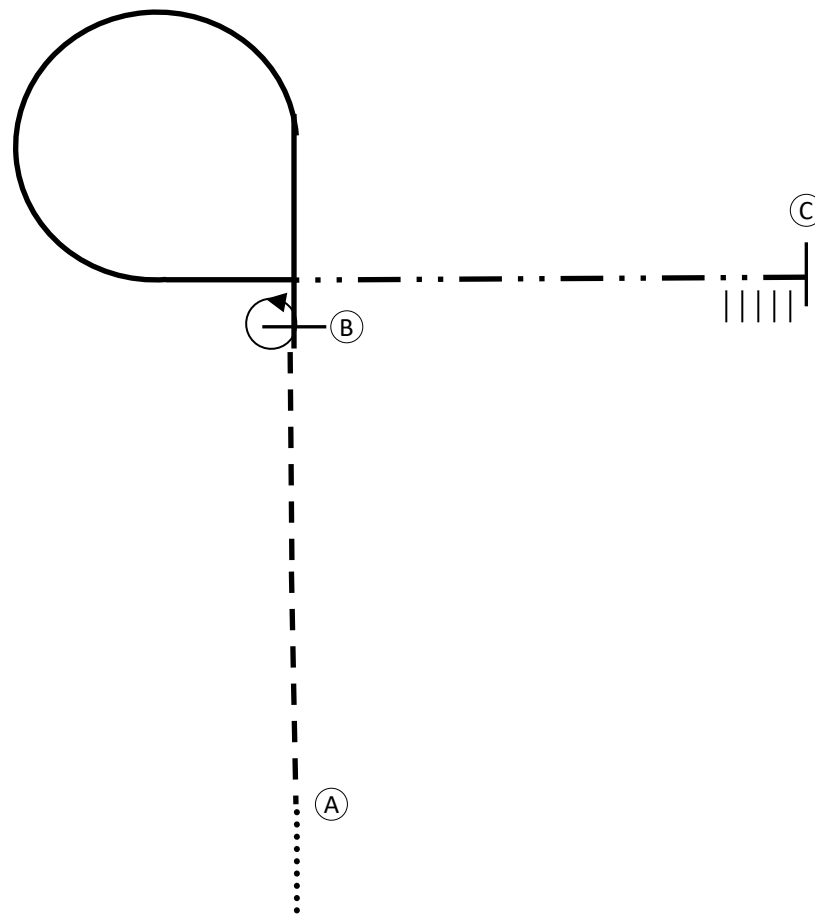

Ranch Trail

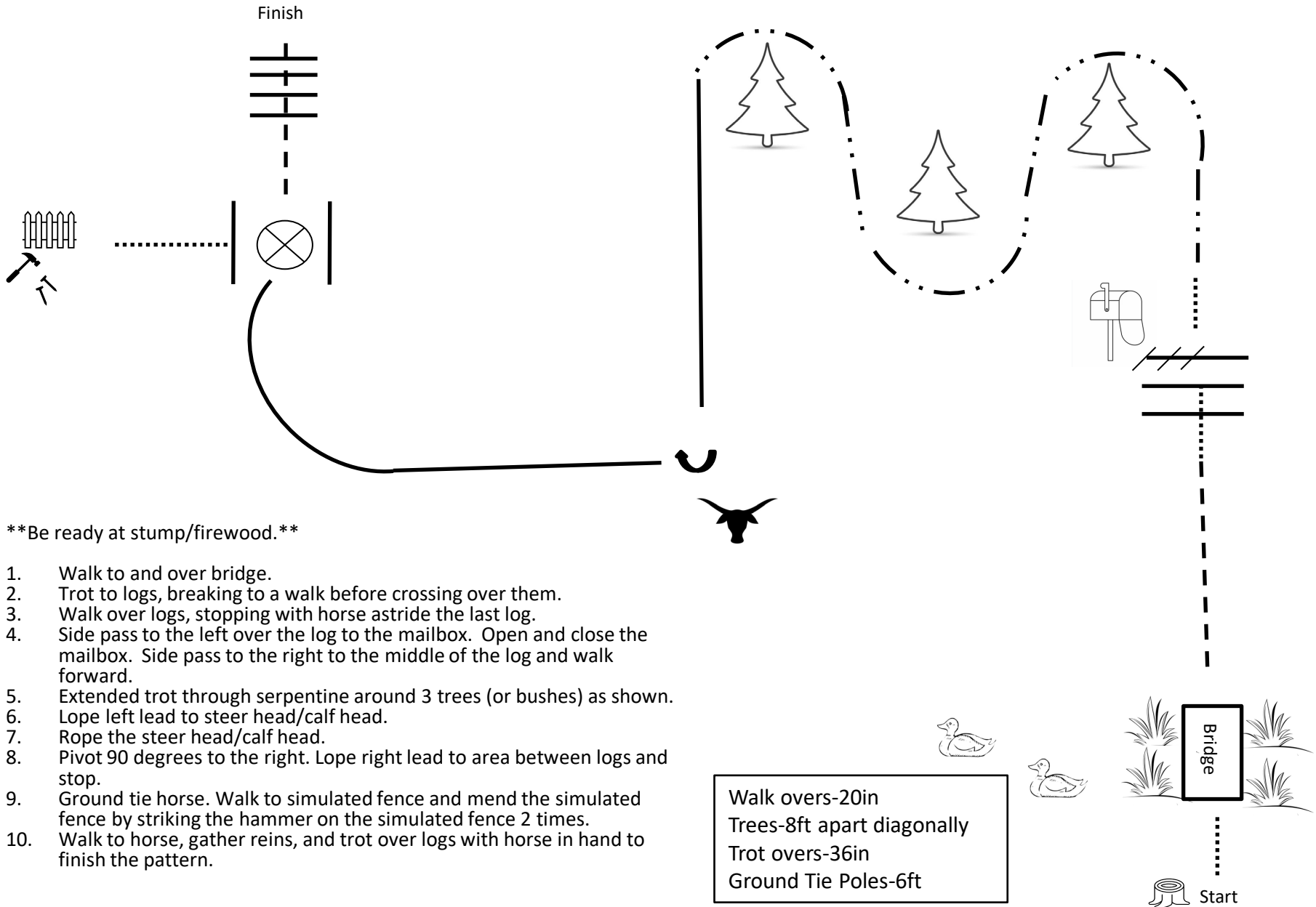

****Be ready at stump/firewood.****

1. Walk to and over bridge.
2. Trot to logs, breaking to a walk before crossing over them.
3. Walk over logs, stopping with horse astride the last log.
4. Side pass to the left over the log to the mailbox. Open and close the mailbox. Side pass to the right to the middle of the log and walk forward.
5. Extended trot through serpentine around 3 trees (or bushes) as shown.
6. Lope left lead to steer head/calf head.
7. Rope the steer head/calf head.
8. Pivot 90 degrees to the right. Lope right lead to area between logs and stop.
9. Ground tie horse. Walk to simulated fence and mend the simulated fence by striking the hammer on the simulated fence 2 times.
10. Walk to horse, gather reins, and trot over logs with horse in hand to finish the pattern.

Walk overs-20in
 Trees-8ft apart diagonally
 Trot overs-36in
 Ground Tie Poles-6ft

Start

****Be ready at cone****

1. Jog/Trot/Show Gait through serpentine as shown.
2. Lope right lead/Extended Show Gait over poles.
3. Walk over bridge.
4. Jog into chute and stop.
5. Back through chute as shown.
6. Lope left lead/Extended Show Gait.
7. Jog through box and into box.
8. Perform a 360° turn to the right and walk out.
9. Walk to and work gate.

****Exit at the walk when finished.****

Trail

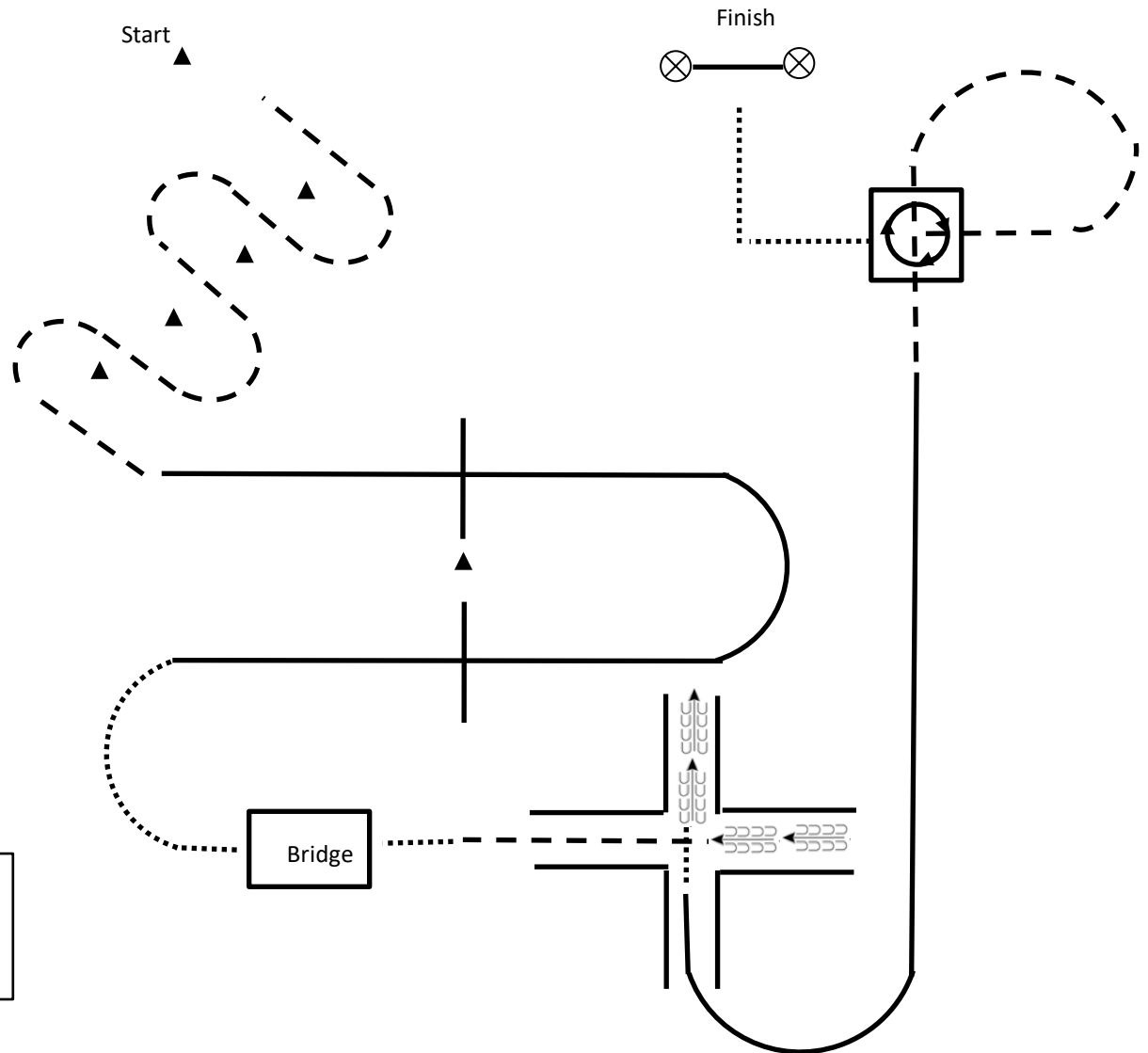

Box-7ft
Back Through Poles-30in apart
Cones-8ft apart

****Be ready at cone****

1. Jog/Trot/Show Gait through serpentine as shown.
2. Sidepass right over pole.
3. Perform a 180° turn to the right.
4. Sidepass left over pole.
5. Walk and send animal over bridge.
6. Jog/Trot/Show Gait into chute and stop.
7. Back through chute as shown. Walk away from chute.
8. Jog/Trot/Show Gait through box and into box.
9. Perform a 360° turn to the right and walk out.
10. Put sheet on animal, wait 5-10 seconds, take sheet off animal and place back on obstacle.

****Exit the arena at the walk when finished.****

Trail in-Hand

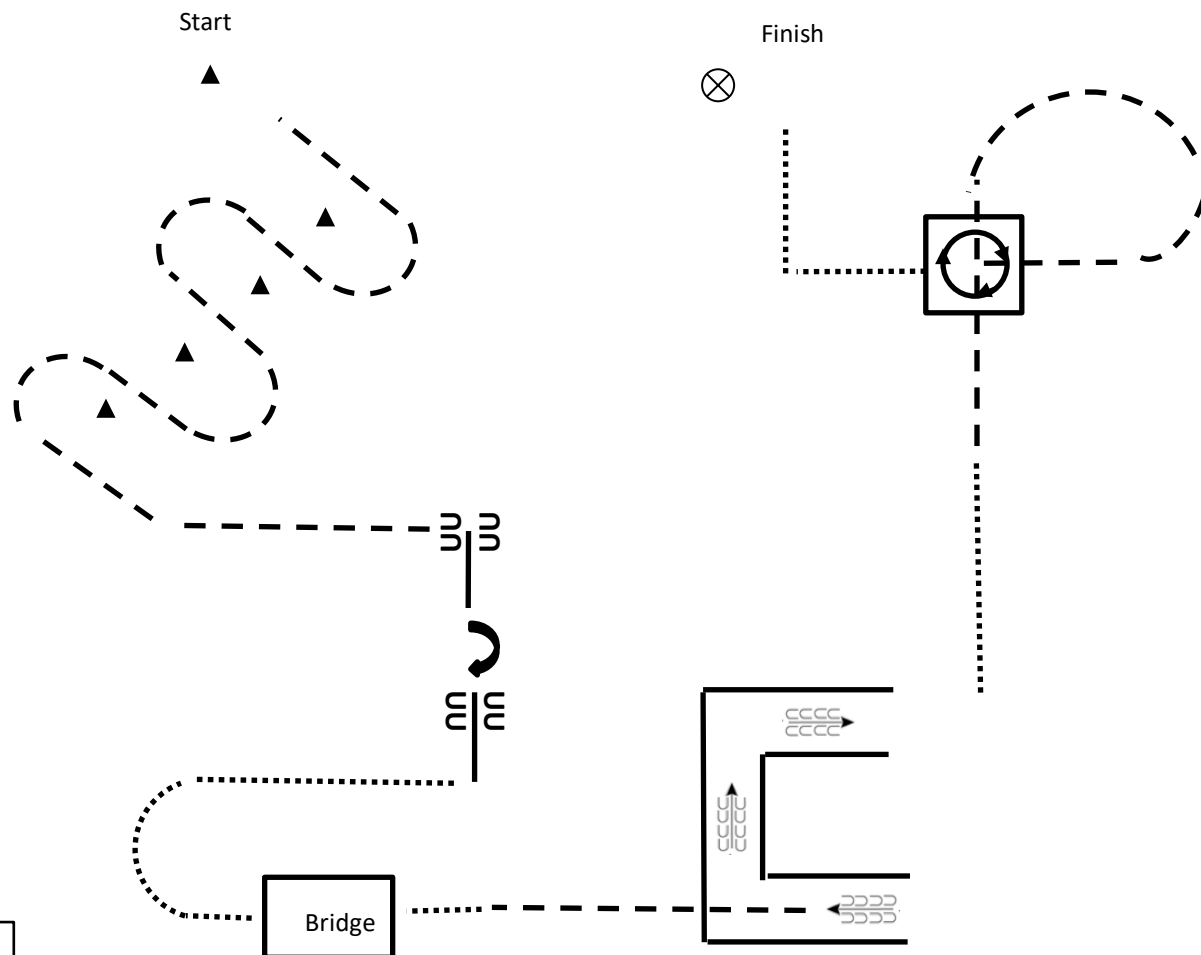

Box-Sm Eq: 4ft Pony & Horse:7ft
Back Through Poles-40in apart
Cones-8ft apart

Western Riding

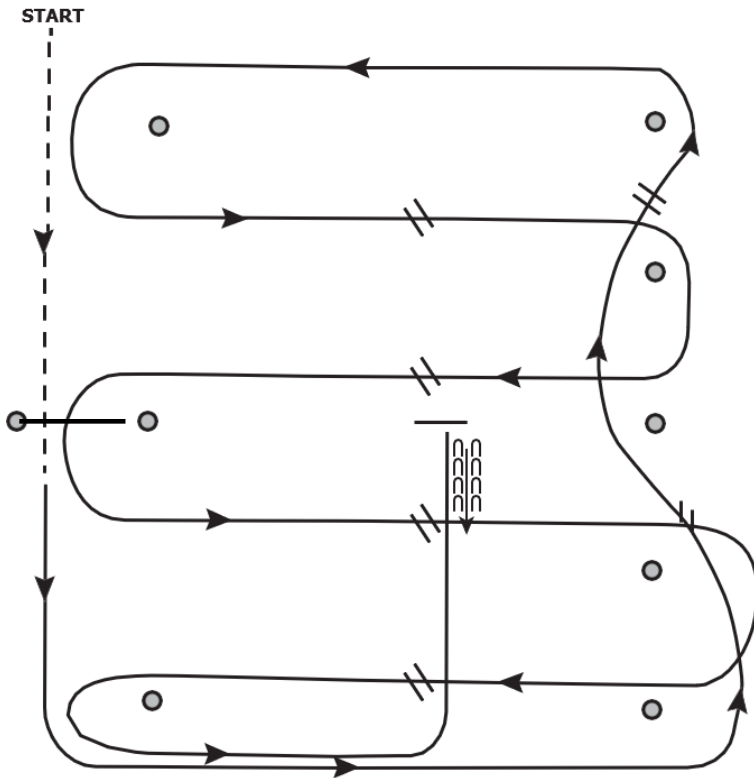

Maneuvers for Western Riding Pattern C

1. Walk to the first pylon and begin jogging to and over the log.
2. Transition to left lead lope and lope around the pylon.
3. First line change.
4. Second line change.
5. Lope around pylon.
6. Lope around pylon and first crossing change.
7. Second crossing change.
8. Lope over log.
9. Third crossing change.
10. Fourth crossing change.
11. Lope up the center, stop, and back.

PATTERN C

Reining

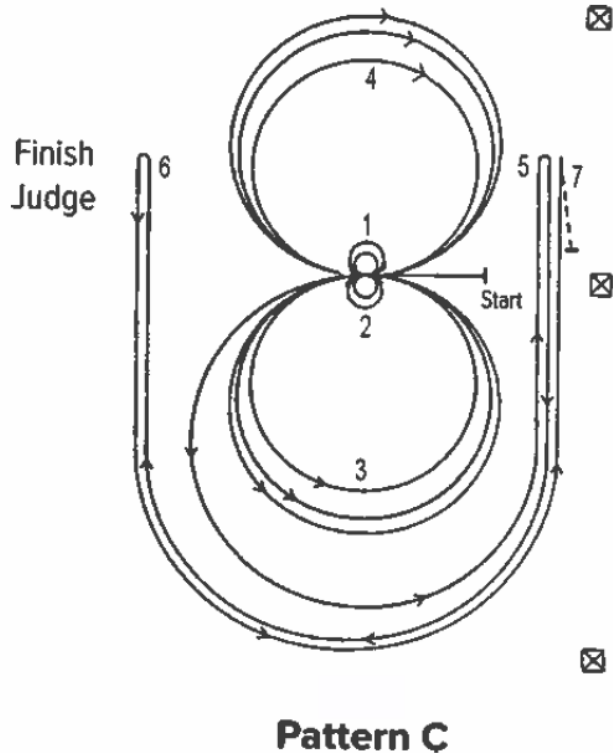

Maneuver 1

Walk to the center of the arena and complete two spins to the right. Hesitate.

Maneuver 2

Complete two spins to the left. Hesitate.

Maneuver 3

Begin on the left lead. Complete two large fast circles to the left. Then do one small slow circle to the left and then do a flying lead change.

Maneuver 4

Complete two large fast circles to the right and one small slow circle to the right. And then do a flying lead change.

Maneuver 5

Begin a large fast circle to the left. Do not close this circle, but run down the side past the center marker and do a right rollback at least 20 feet from the arena fence.

Maneuver 6

Continue back around the previous circle, run down the opposite side of the arena past the center marker, and do a left rollback at least 20 feet from the arena fence.

Maneuver 7

Continue back around the previous circle. Do not close this circle but run down the side past the center marker and do a sliding stop. Back straight to the center of the arena or at least 10 feet. Hesitate to indicate completion of the pattern and then exit the arena.

Ranch Riding

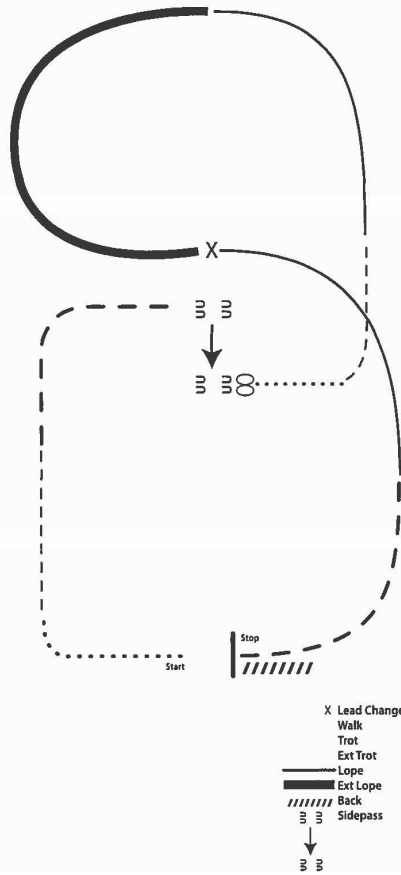

1. Walk.
2. Trot.
3. Extended trot to center of arena.
4. Stop and side pass to the right.
5. Turn 360° to the right, stop, and then turn 360° to the left.
6. Walk.
7. Trot.
8. Lope left lead.
9. Extend the lope.
10. Perform a simple or flying change of lead.
11. Collect the lope.
12. Extend the trot.
13. Stop and back.

PATTERN B

Western Showmanship

****Be ready at A.****

1. Jog halfway to B.
2. Walk until even with Judge.
3. Stop. Execute a 270° turn. Walk to Judge.
4. Stop and set up for inspection.
5. When excused, back 3 steps. Perform a 90° turn.
6. Jog around B and back toward A.
7. Walk before A and exit at a Walk.

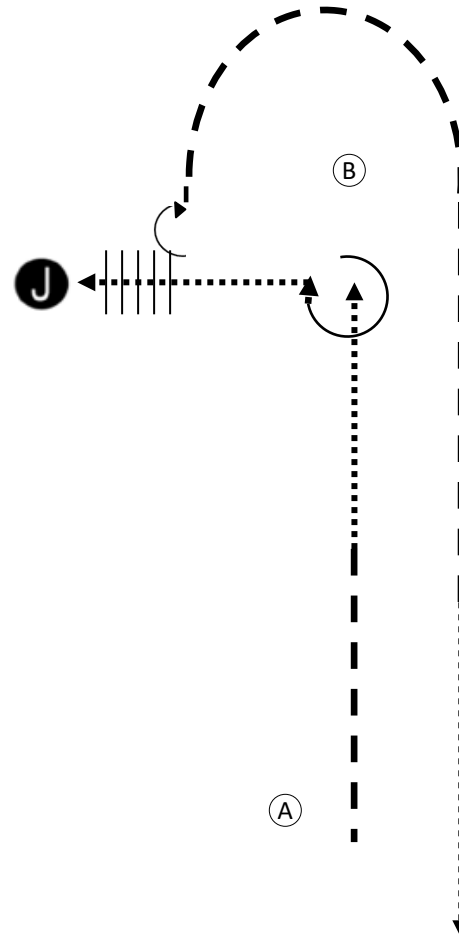

Western Horsemanship

****Be ready at A.****

1. Walk to B.
2. At B lope a circle to the left on the left lead.
3. Upon completion of circle, transition to jog and jog from B to C.
4. Stop. Complete a 360° turn on haunches to the left.
5. Lope right lead to D.
6. Stop & back 4 steps.

****Jog to exit.****

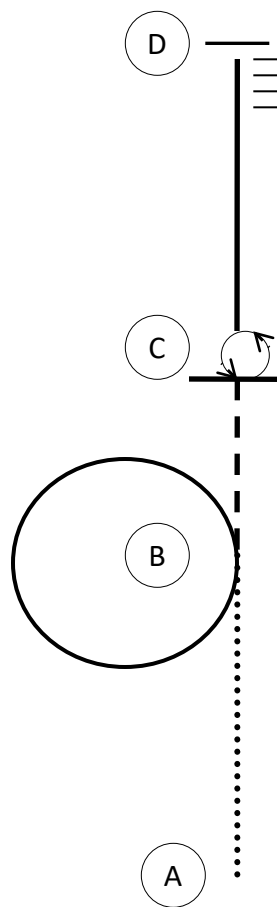

Hunt Seat Showmanship

**** Be ready at A****

1. Trot to and around B.
2. Walk from B until past judge.
3. Back until horse's hip is even with Judge.
4. Perform a 90° turn.
5. Trot to Judge.
6. Stop and set up for inspection.
7. When dismissed, perform a 270° turn.
8. Walk straight away from Judge.

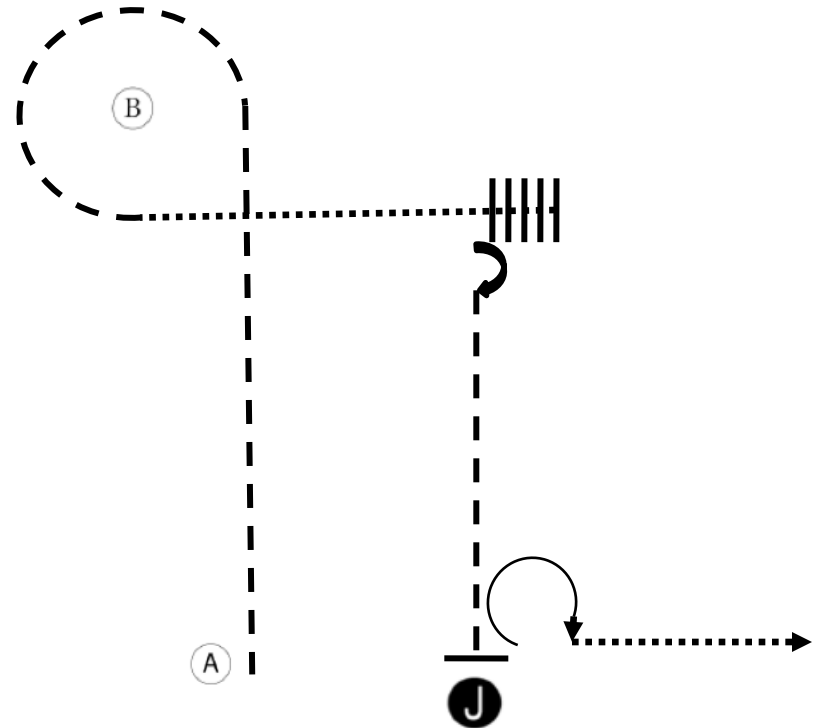

Hunter Hack

Fences are set 72 feet apart.

1. After second fence, hand gallop to marker.
2. Stop and back at least 5 steps.
3. Drop your reins to signal completion.

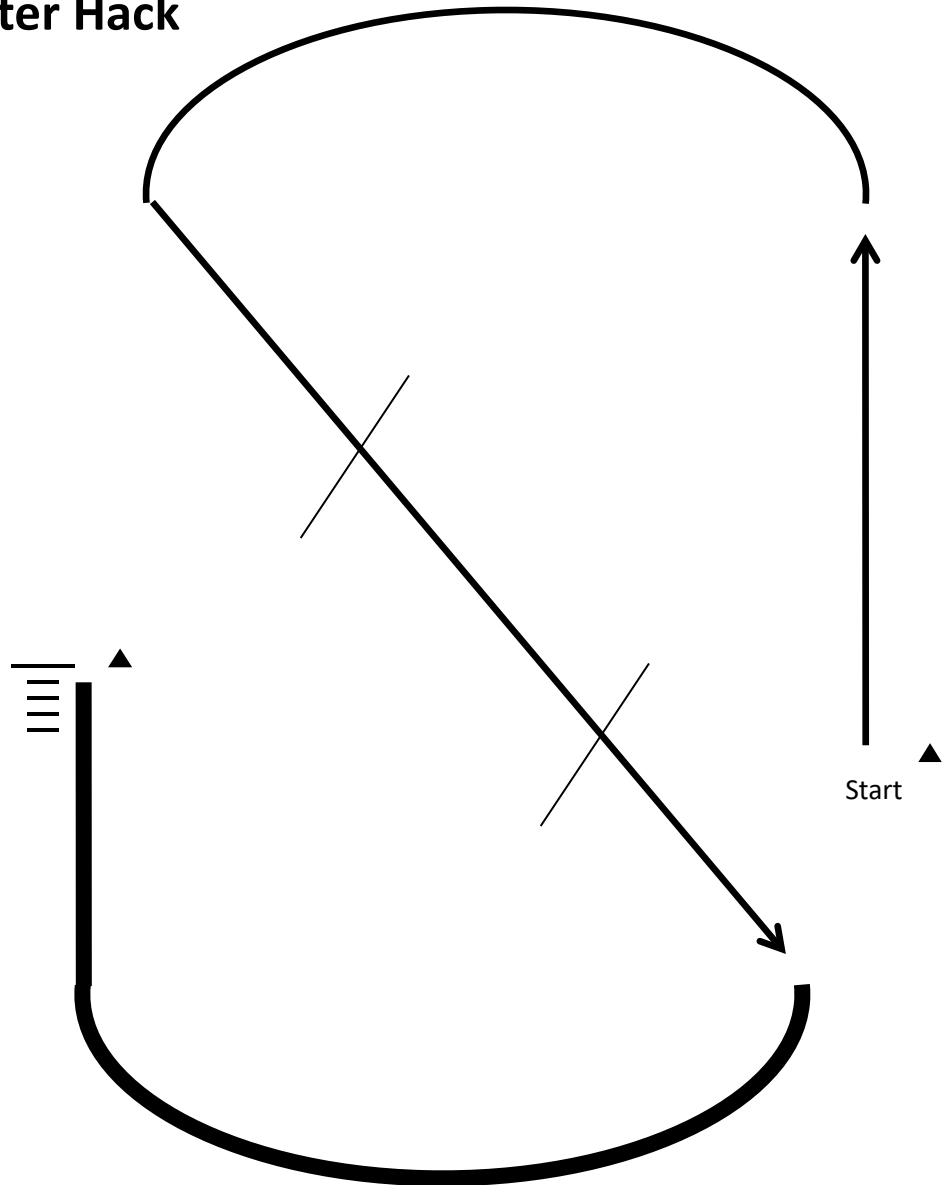

Green and Low Hunter Over Fences

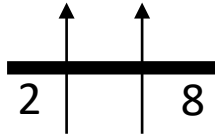

72 ft

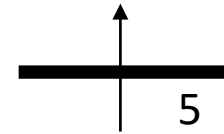
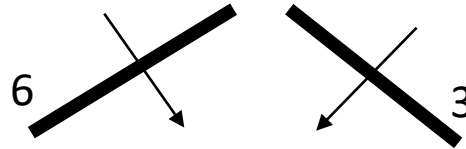

60 ft

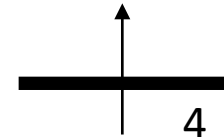
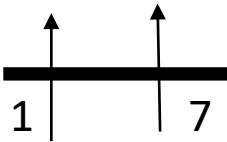

Fence Heights:

Horse/Large Pony – 2'6"

Medium Pony – 2' 3"

Small Pony – 2'

Intermediate & Advanced Equitation Over Fences

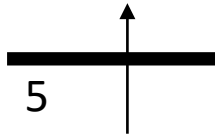

72 ft

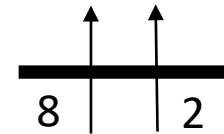
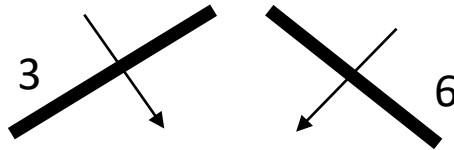

60 ft

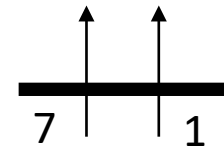
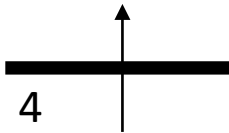

Fence Heights:

Horse/Large Pony – Intermediate: 2'3" Advanced: 2'6"
Medium Pony – Intermediate: 2' Advanced: 2'3"
Small Pony – Intermediate: 18" Advanced: 2'

Hunt Seat Equitation

****Be ready at A.****

1. Walk to B. Stop at B and perform a 90° turn to the right on the forehand.
2. Posting trot on the right diagonal to C.
3. At C, change diagonals and trot to D.
4. At D, canter on the right lead back to C.
5. At C, perform a change of lead and canter back to B.
6. Stop at B and back at least 5 steps.

****Exit at the trot.****

